

Kanal Fanları

“Systemair” Yuvarlak Kanal Fanları

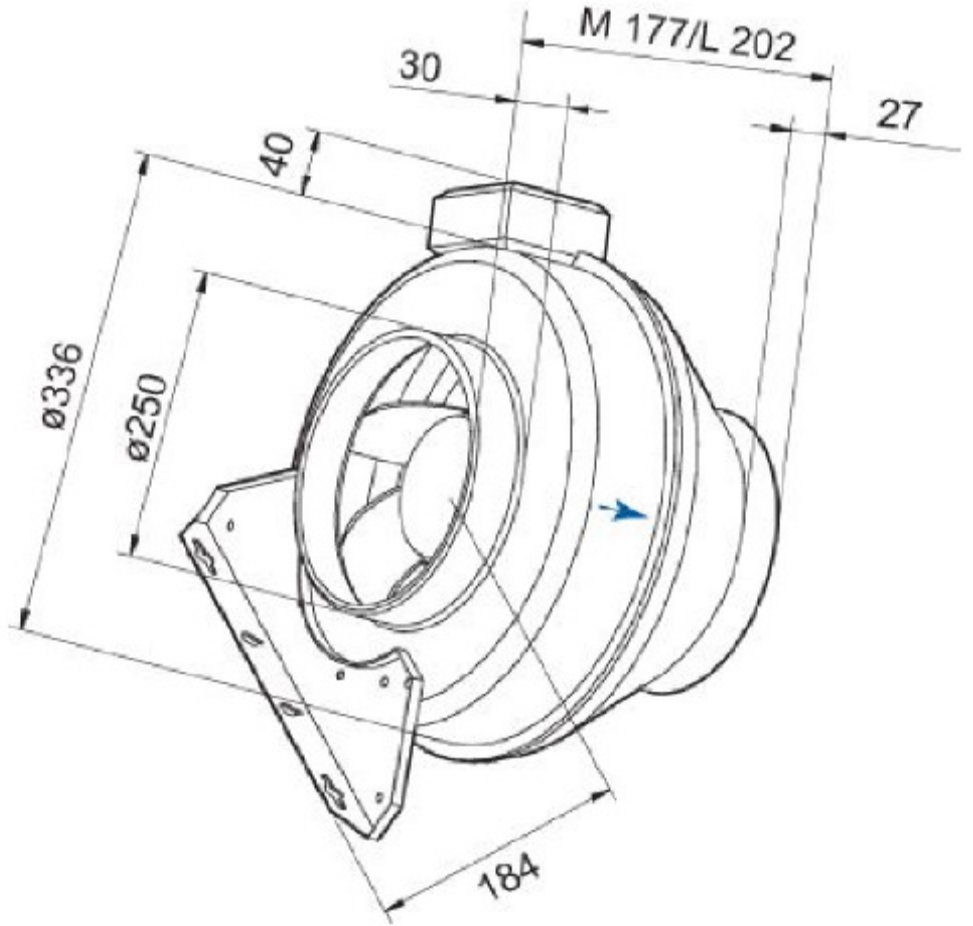

K 250L



Voltage	V	230
Frequency	Hz	50
Phase	~	1
Power	W	157
Current	A	0.7
Maximum air flow	m ³ /h	1000
R.p.m.	1/min	2610
Max. temperature of transported air	°C	55
Max. temperature of transported air when speed-controlled	°C	55
Sound pressure level at 3 m	dB(A)	44
Weight	kg	5
Insulation class, motor		B
Enclosure class, motor		IP 44
Capacitor	µF	4

Performans Eğrisi

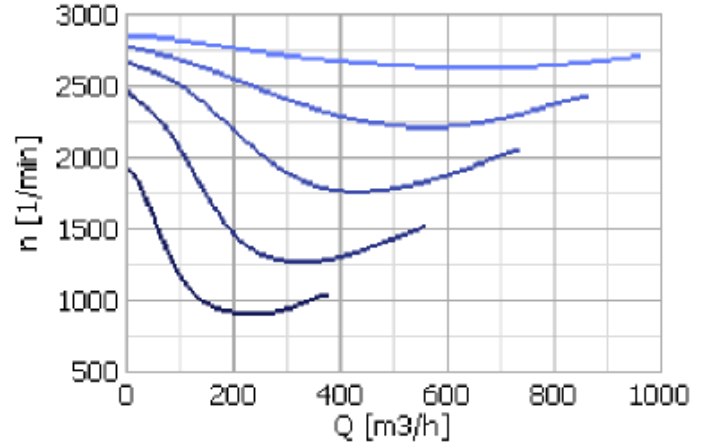
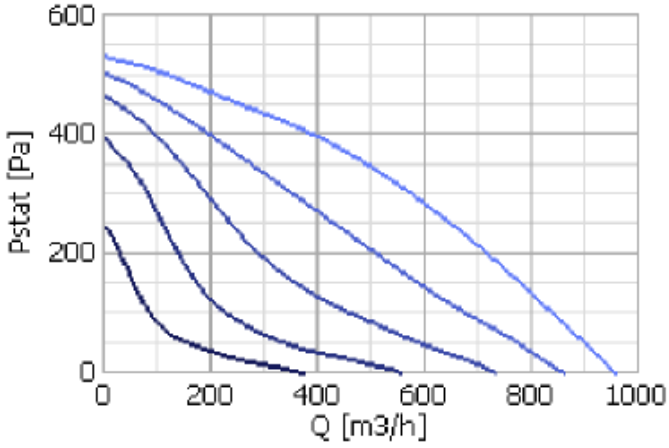

Genel Özellikler:

- Dış ortamda kullanıma uygundur
- Hız kontrolü yapılabilir
- Geriye eğik santrifüj kanat
- Dıştan rotorlu dayanıklı motor (ebmpapst)
- Termal motor koruması
- Galvaniz çelik fan gövdesi