

Kanal Fanları

“Systemair” Yuvarlak Kanal Fanları

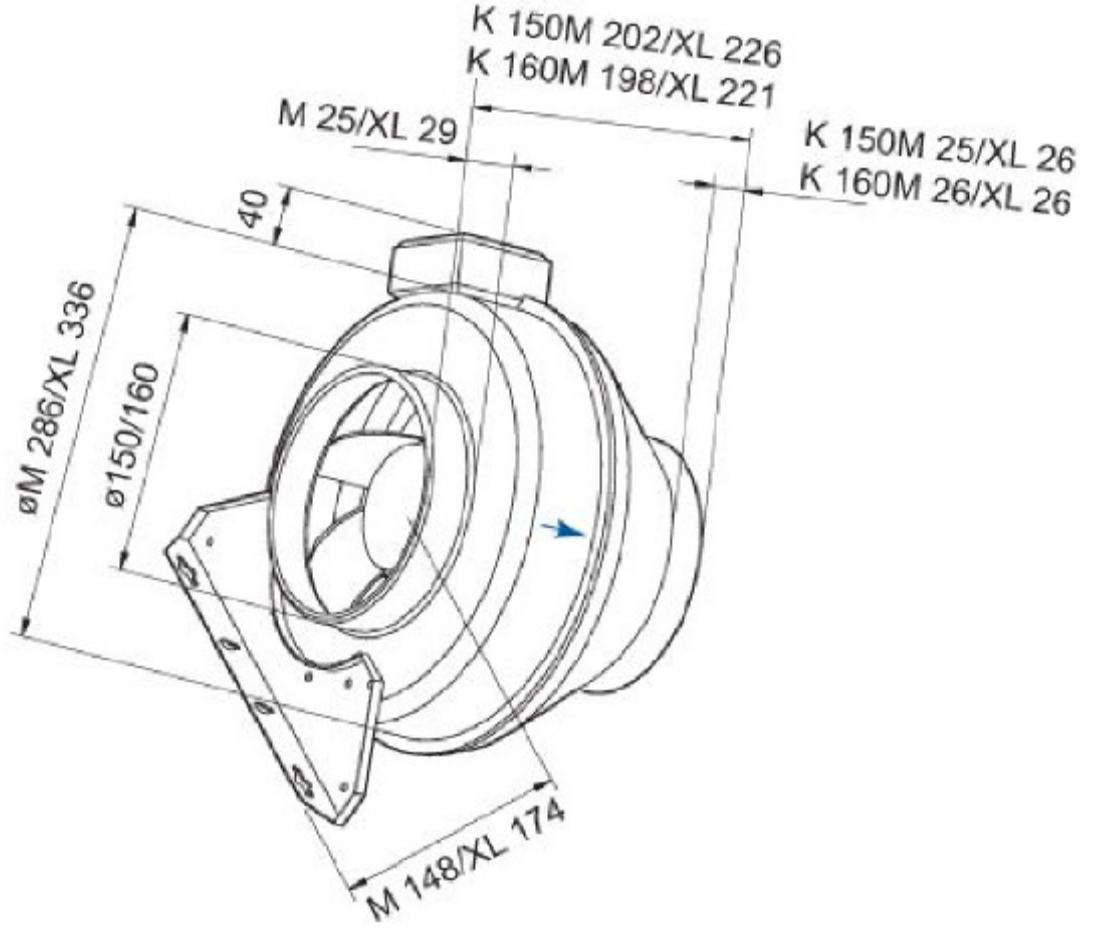

K 150M



Voltage	V	230
Frequency	Hz	50
Phase	~	1
Power	W	63
Current	A	0.27
Maximum air flow	m ³ /h	490
R.p.m.	1/min	2420
Max. temperature of transported air	°C	70
Max. temperature of transported air when speed-controlled	°C	70
Sound pressure level at 3 m	dB(A)	45
Weight	kg	3
Insulation class, motor		B
Enclosure class, motor		IP 44
Capacitor	µF	2

Performans Eğrisi

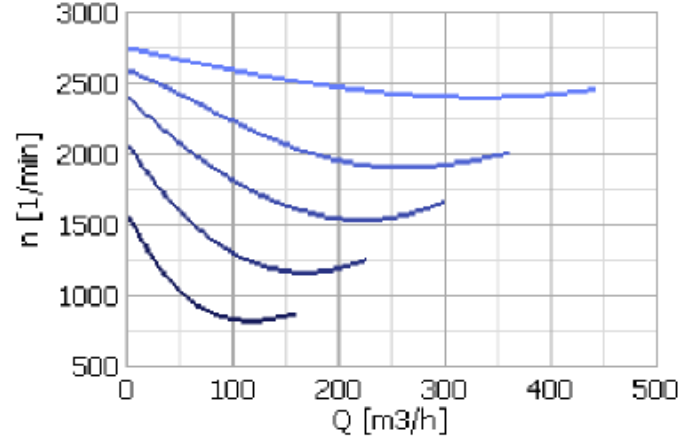
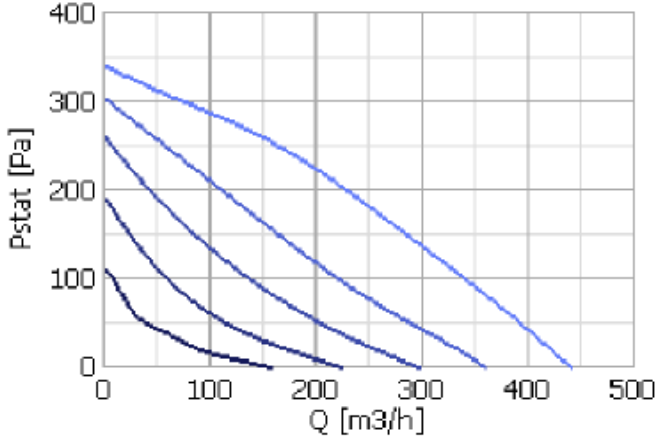

Genel Özellikler:

- Dış ortamda kullanıma uygundur
- Hız kontrolü yapılabilir
- Geriye eğik santrifüj kanat
- Dıştan rotorlu dayanıklı motor (ebmpapst)
- Termal motor koruması
- Galvaniz çelik fan gövdesi