

Fanlar



“ebmpapst” Kompakt Aksiyel Fanlar

W2E142 BB05- 01

Phase		1~	1~
Nominal voltage	[V]	115	115
Frequency	[Hz]	50	60
Type of data definition		rfa	rfa
Valid for approval / standard		CE	CE
Speed	[min ⁻¹]	2800	3350
Power input	[W]	27	28
Current draw	[A]	0,24	0.25
Motor capacitor	[µF]	3	3
Capacitor voltage	[VDB]	220	220
Capacitor standard		P0 (CE)	P0 (CE)
Max. ambient temperature	[°C]	55	65
Air flow	[m ³ /h]	320	380
Back pressure	[Pa]	0	0
Sound pressure level	[dB(A)]	51	56

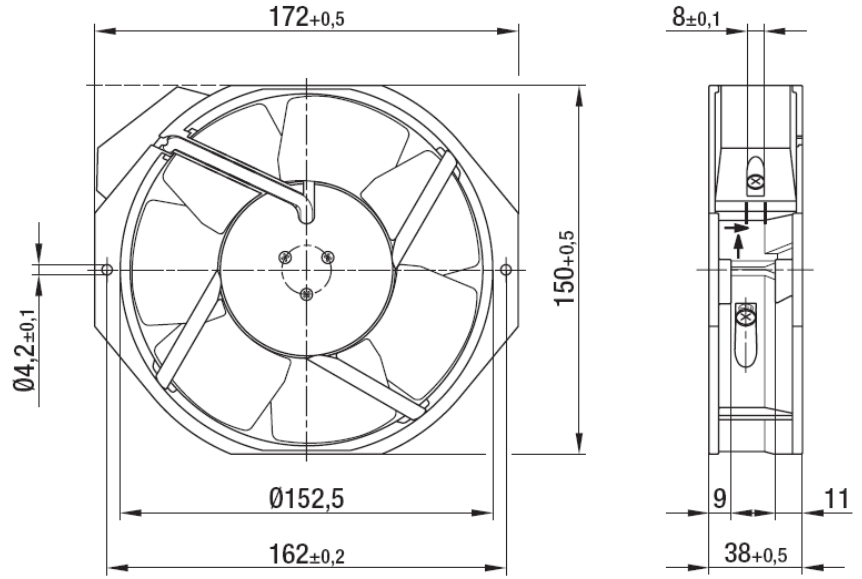

Performans (50 Hz) :

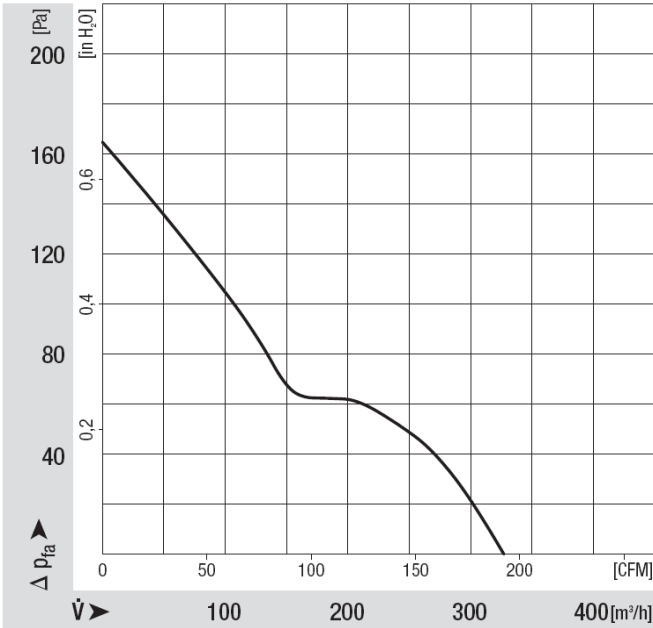

Bağlantı: